

Designed for safety. Built for fun.

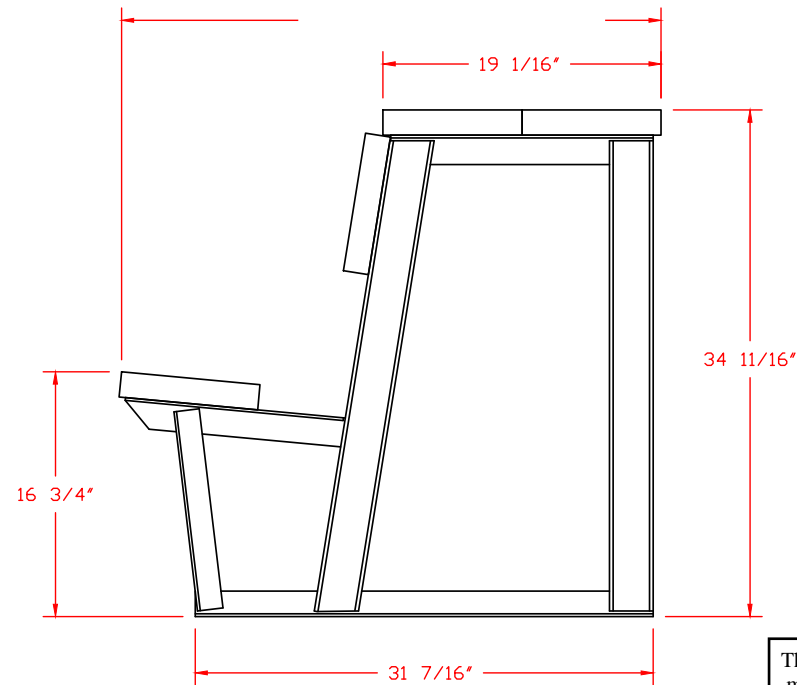
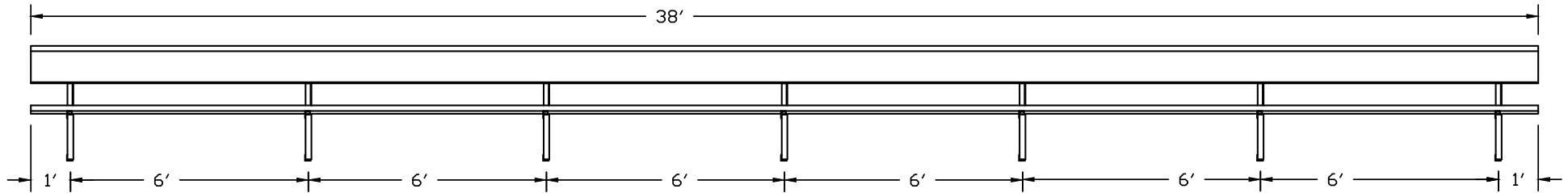

GENERAL SPECIFICATIONS

- ALL ALUMINUM UNDERSTRUCTURE
- 2x10 ANODIZED SEAT PLANK
- 2x10 ANODIZED BACKREST PLANK
- (2) 2x10 ANODIZED PLANK UPPER SEAT AREA
- RECOMMEND CONCRETE PAD FOR ANCHORAGE (BY OTHERS)

NET SEATING CAPACITY - 25

The Manufacturer warrants its bleacher products to be free from defects in materials and workmanship for a period of five (5) years beginning with the date the product is completed at the job site. Product installation can be performed by factory trained personnel or by the customer personnel following the detailed assembly instructions of the manufacturer. This warranty excludes all other defects resulting from abnormal use or abuse, accidental damage or any occurrences beyond the manufacturers control.



38' Players Bench with Double Upper Shelf